



TWRN-9161201-191

2.4GHz + 5GHz WiFi Antenna



2.4GHz+5GHz
BTWS-WRN-9151201-191

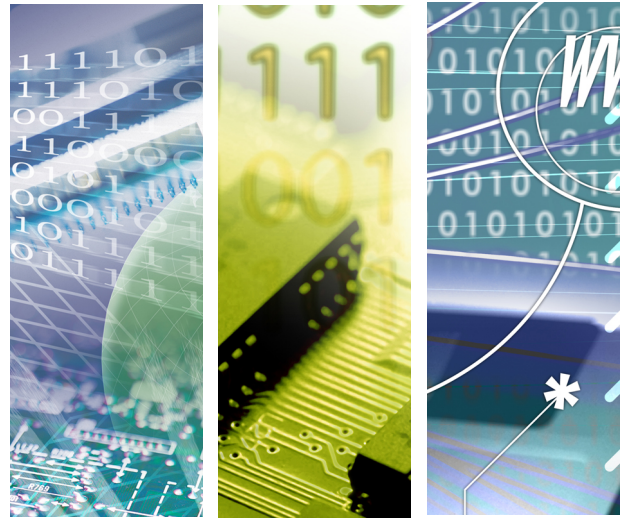

TWRN-9161201-191

High Sensitivity Type Wifi Antenna

Introduction of Product

- 1.Frequency: 2400--2500MHz
5150--5900MHz
- 2.VSWR: 2400--2500MHz:≤2.0
5150--5900MHz:≤2.0
- 3.Gain: 2400--2500MHz:2.48dBi
5150--5900MHz:5.18dBi
- 4.Connector:rp-sma
- 5.Dimensions:19.5cm*1.3cm*1.3cm

Product Highlight

- 1.dual Frequency in one unit
- 2.VSWR:≤2.0
- 3.High Gain in 5GHz
- 4.Polarization Type: Linear
- 5.Input Impedance:50 Ohms nominal
- 6.Connector Type:RP-SMA
- 7.Install the Way:Adsorption

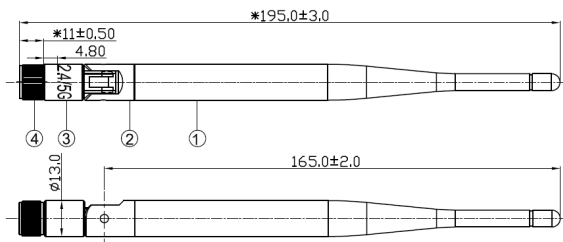

Specification

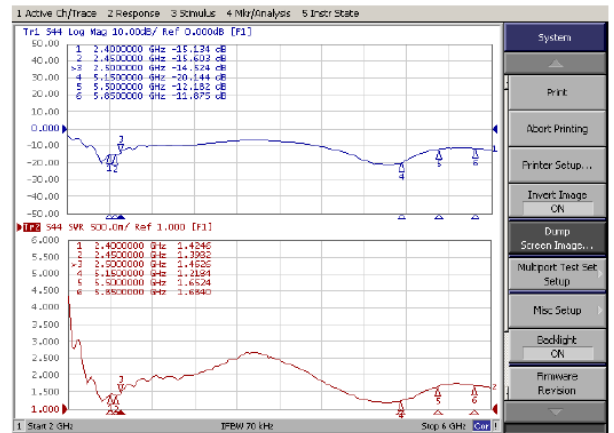
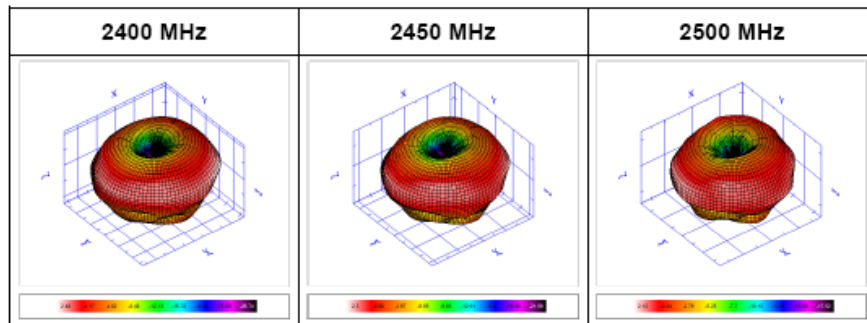
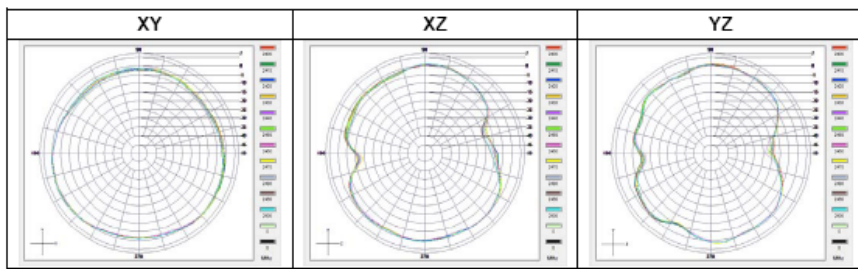

Frequency	2400	2410	2420	2430	2440	2450	2460	2470	2480	2490	2500
TRP (dBm)	-1.04	-1.08	-1.13	-1.12	-1.93	-1.14	-1.19	-1.14	-1.09	-1.18	-1.15
Peak RIRP (dBm)	2.48	2.47	2.13	2.18	1.93	2.3	2.07	2.35	2.29	1.93	2.12
RHFRP +/- 45 (degree)	-1.56	-1.59	-1.63	-1.61	-2.01	-1.61	-1.66	-1.61	-1.55	-1.62	-1.58
RHFRP +/- 30 (degree)	-2.56	-2.6	-2.61	-2.54	-2.95	-2.55	-2.62	-2.58	-2.52	-2.58	-2.55
E-Theta Peak Gain (dBi)	-11.1	-11.81	-11.99	-12.13	-11.94	-11.27	-11.82	-12.63	-12.69	-12.94	-12.44
E-Phi Peak Gain (dBi)	2.4	2.37	2.05	2.14	1.9	2.27	2.03	2.32	2.22	1.92	2.09
E-Total Peak Gain (dBi)	2.48	2.47	2.13	2.18	1.93	2.3	2.07	2.35	2.29	1.93	2.12
Directivity (dBi)	3.52	3.55	3.26	3.3	3.46	3.43	3.26	3.49	3.38	3.11	3.26
Efficiency (%)	78.67	77.98	77.03	77.22	70.34	76.99	76.11	76.86	77.75	76.12	76.78
Average Gain (dB)	-1.04	-1.08	-1.13	-1.12	-1.93	-1.14	-1.19	-1.14	-1.09	-1.18	-1.15

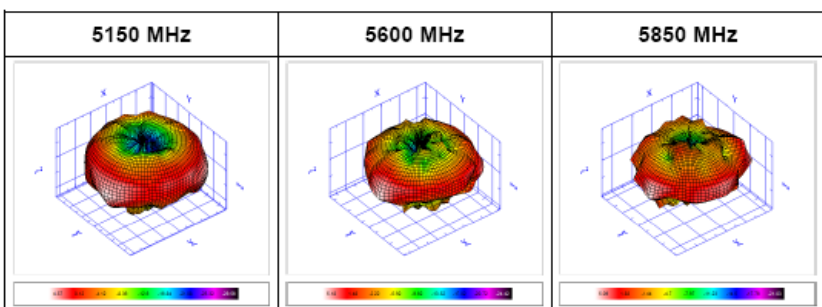
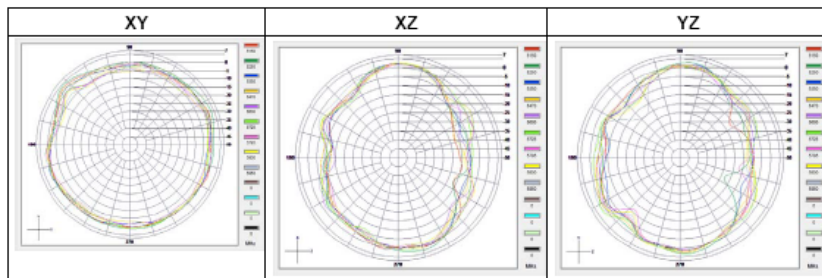

Frequency	5150	5250	5350	5470	5500	5725	5785	5800	5850
TRP (dBm)	-1.29	-0.59	-1.68	-1.56	-1.79	-1.48	-1.56	-1.51	-1.04
Peak RIRP (dBm)	4.37	4.82	4.08	4.58	5.18	4.04	4.59	3.9	5.09
RHFRP +/- 45 (degree)	-1.55	-0.88	-2.01	-1.95	-2.23	-2.04	-2.1	-2.11	-1.62
RHFRP +/- 30 (degree)	-1.88	-1.15	-2.3	-2.23	-2.54	-2.47	-2.53	-2.59	-2.16
E-Theta Peak Gain (dBi)	-10.09	-7.71	-7.89	-8.95	-6.4	-4.24	-5.98	-6.72	-5.59
E-Phi Peak Gain (dBi)	4.34	4.81	4.02	4.55	5.17	3.93	4.55	3.86	5.02
E-Total Peak Gain (dBi)	4.37	4.82	4.08	4.58	5.18	4.04	4.59	3.9	5.09
Directivity (dBi)	5.66	5.41	5.76	6.14	6.97	5.51	6.15	5.41	6.14
Efficiency (%)	74.24	87.31	67.89	69.85	66.26	71.13	69.8	70.55	78.66
Average Gain (dB)	-1.29	-0.59	-1.68	-1.56	-1.79	-1.48	-1.56	-1.51	-1.04



 TAIJET BOINTEC CO LTD
 4F, #114, Zhouzi St., Neihu-Taipei 11493, Taiwan
 TEL: +886-2-2759-0081
 WWW.BOINTEC.COM

Bointec Authorized Distributer